

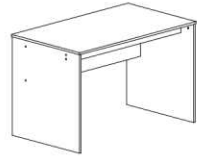

**ASSISTANT**  
**AS-021-pi**  
 1200\*700\*760





70014,00 	70015,00 	22300,00 		21100,00  Ø1,6x20	30100,07 
A 10x	B 10x	C 8x	D 8x	E 8x	F 4x



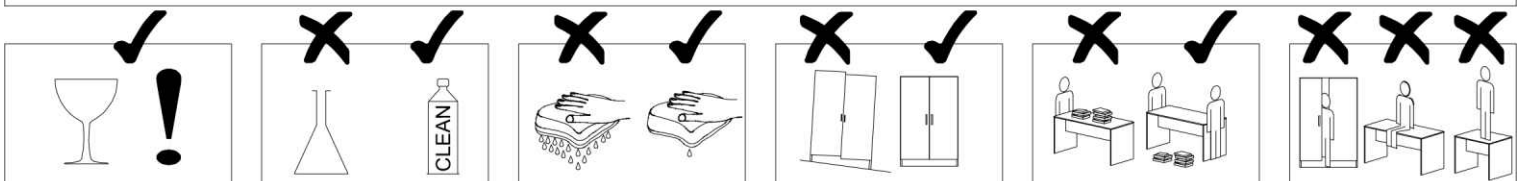
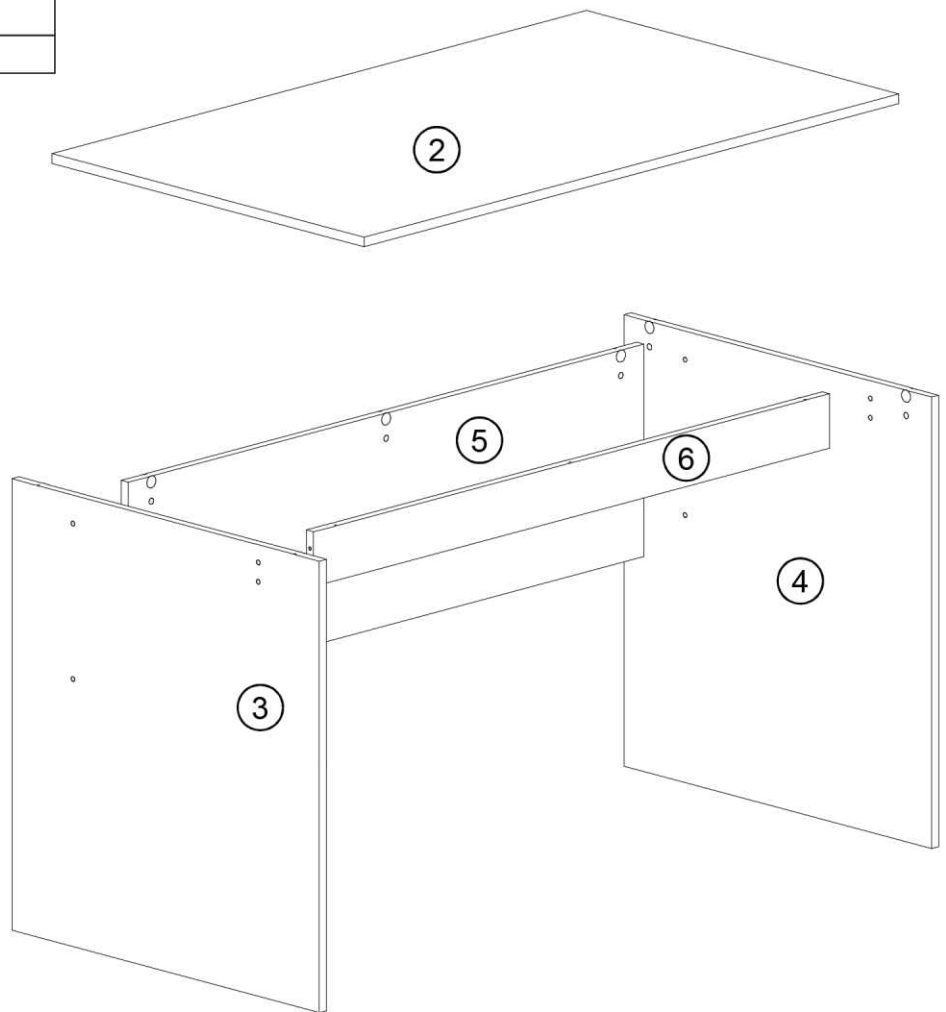

 0h 30min		 4		 ≤ 0,5 kg	
--------------	--	-------	--	--------------	--

ID	ID	ID	ID	ID
00128	②	1200*700*16	1x	1/1
00123	③	744*690*16	1x	1/1
00124	④	744*690*16	1x	1/1
00129	⑤	1158*350*16	1x	1/1
00130	⑥	1158*90*16	1x	1/1

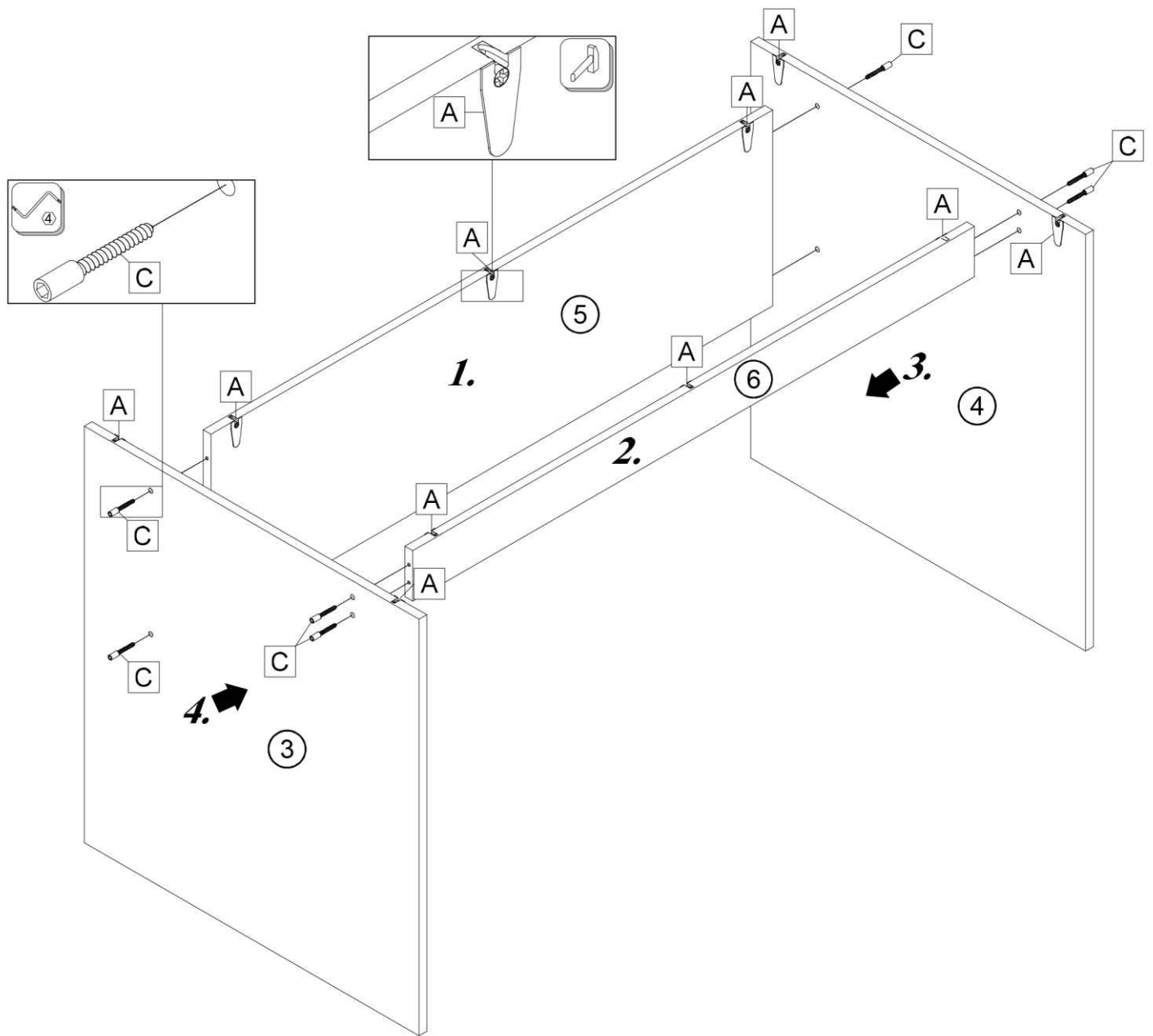

	
A 10x	C 8x



			
B 10x	D 8x	E 8x Ø1,6x20	F 4x

