

OFÉLIE

EAC

Šatní skříň se zrcadlem

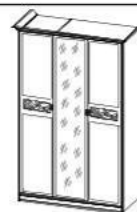





	1472
	2080
	670

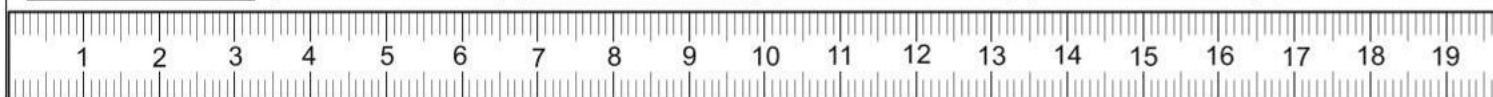
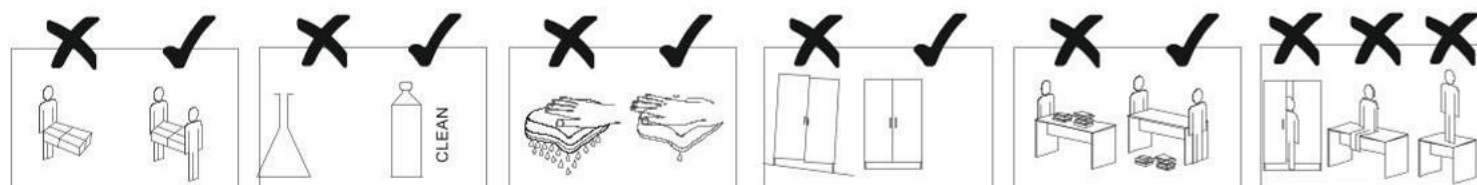
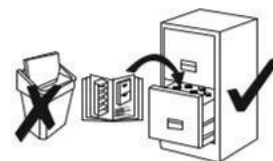



A x44	B x32	C x28	D x8	E x6	F x26	G x6	I x12	H x12	J x28
K x2	L x30	M x1	N x3	O x8	P x3	R x4	S x22	T x4	U x6
Y x1	X x2	Z x4	V x4						

--	--	--	--	--	--	--	--	--

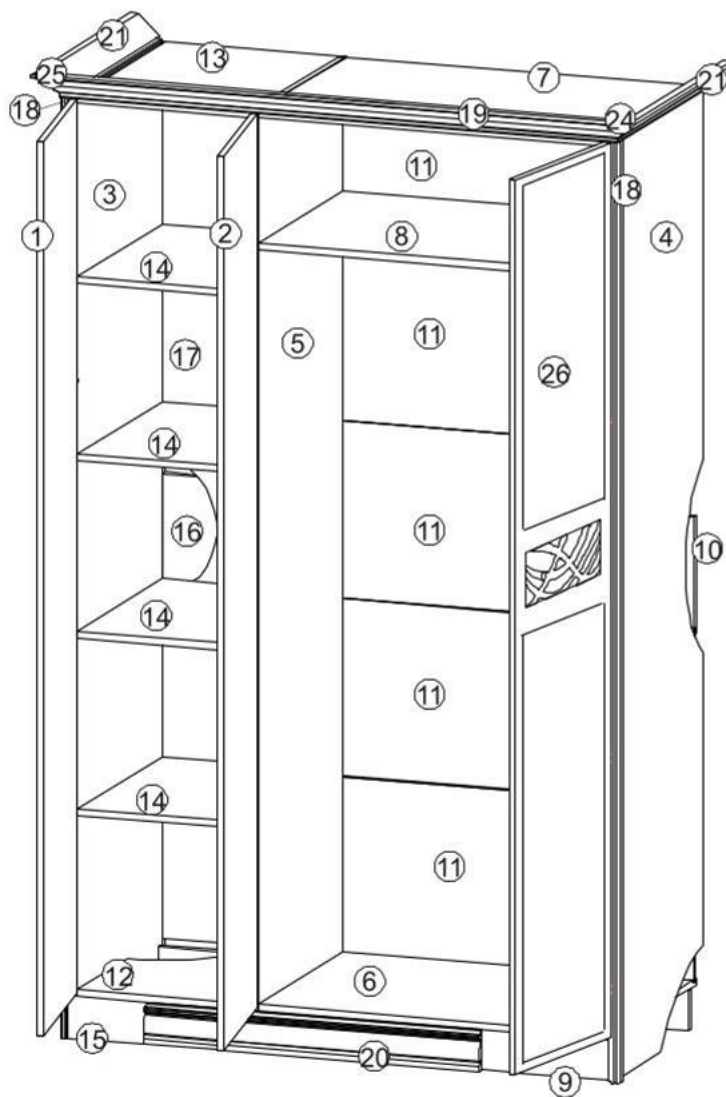

						W	L	H
①			695011.000	1	6	2108	440	22
②			690012.000	1	6	2108	440	22
③			690010.001	1	3	2217	590	16
④			690010.002	1	3	2217	590	16
⑤			690010.003	1	4	2217	590	16
⑥			637060.011	1	1	854	589	16
⑦			637060.012	1	1	854	589	16
⑧			690010.004	1	1	854	568	16
⑨			637390.005	2	1	854	96	16
⑩			637370.005	1	1	854	279	16
⑪			695010.001	5	1	417	862	3
⑫			637040.011	1	2	426	589	16
⑬			637040.012	1	2	426	589	16
⑭			690010.005	4	2	568	426	16
⑮			637040.013	2	2	426	96	16
⑯			637040.014	1	2	426	279	16
⑰			695010.002	1	4	2096	434	3
⑱			690010.006	2	5	2217	22	44
⑲			690010.007	1	5	98	1326	22
⑳			690010.008	1	5	96	1328	12
㉑			690010.009	2	5	576	65	54
㉒			633300.001	4	5	50	40	12
㉓			633300.001	1	5	50	40	12
㉔			СКп 90	1	5			
㉕			СКл 90	1	5			
㉖			695013.000	1	6	2108	440	22



			
B x32	I x12	T x4	X x2

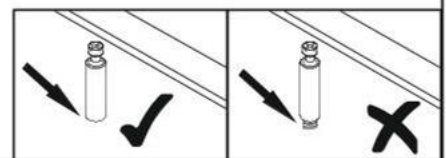
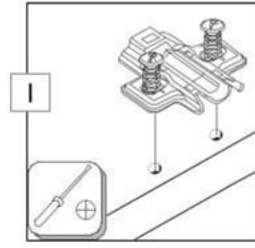
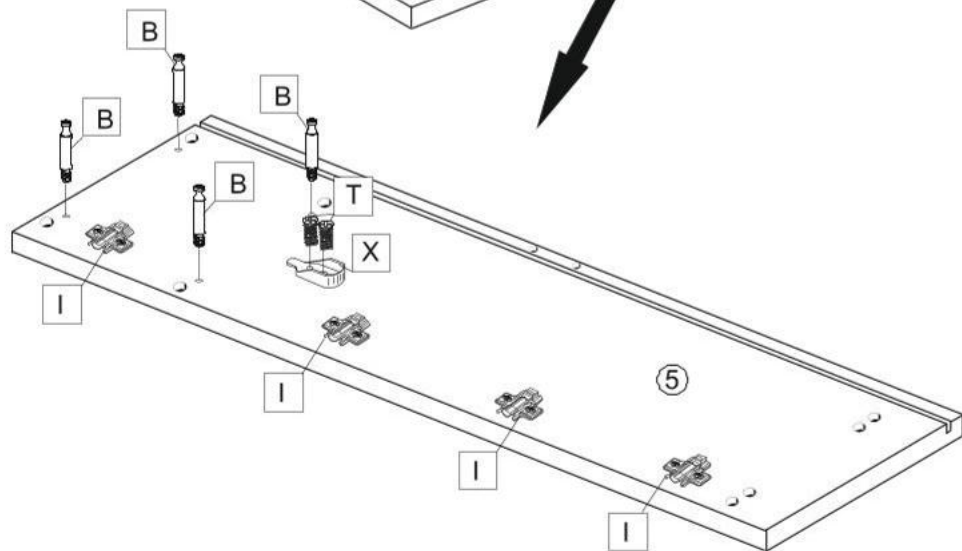
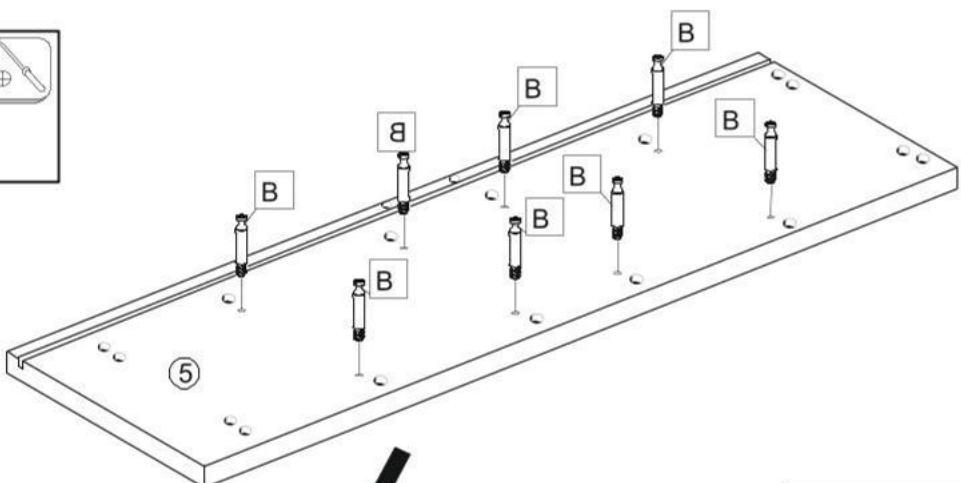
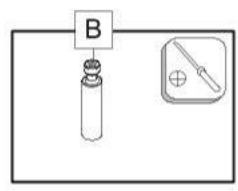
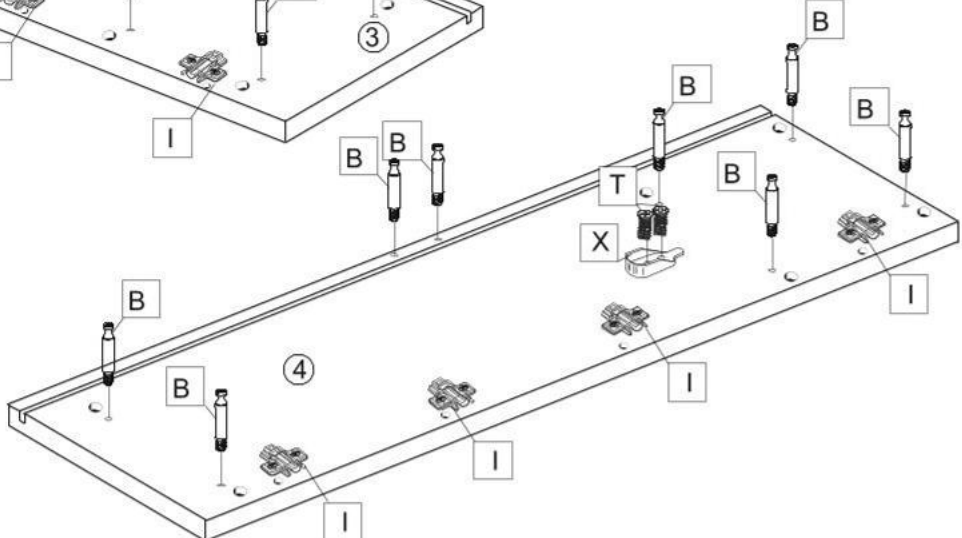
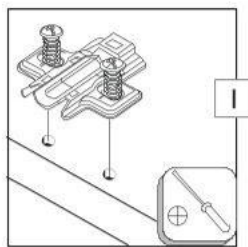
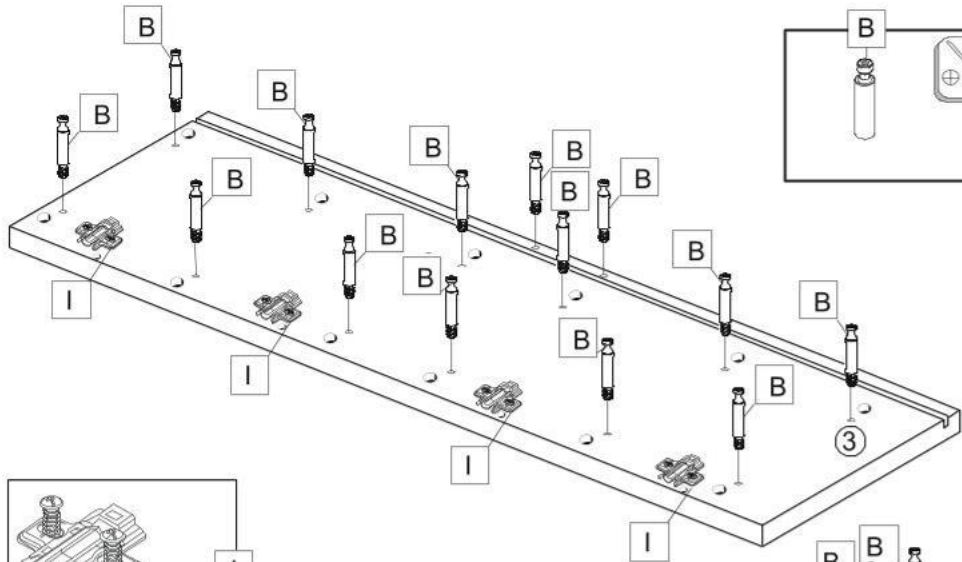
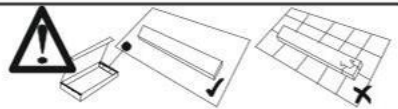



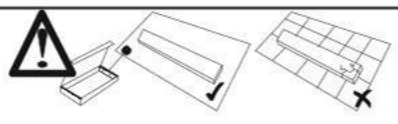

8x30

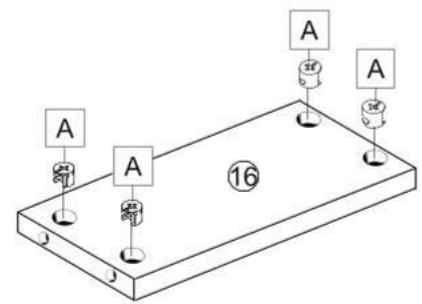
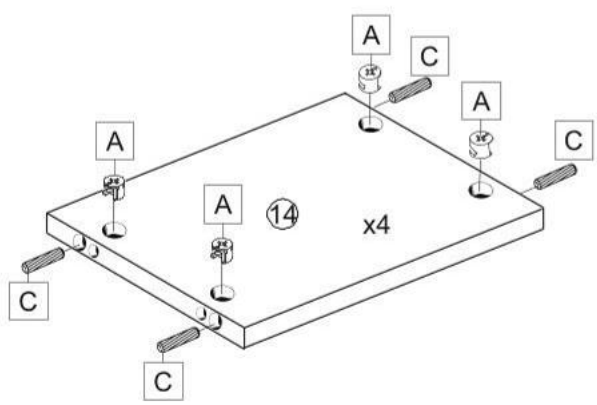
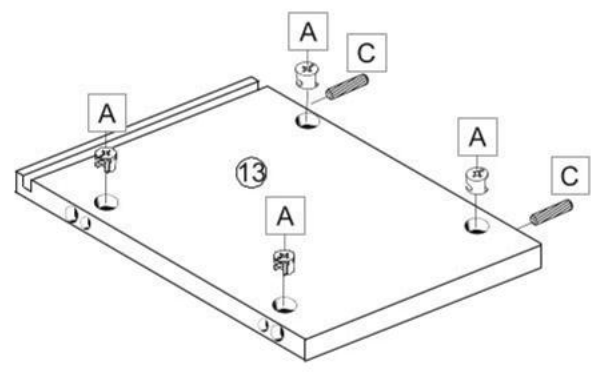
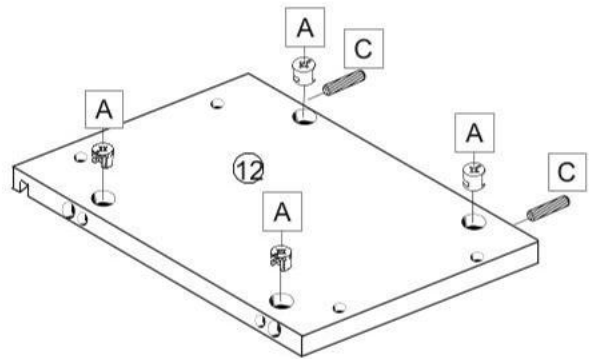
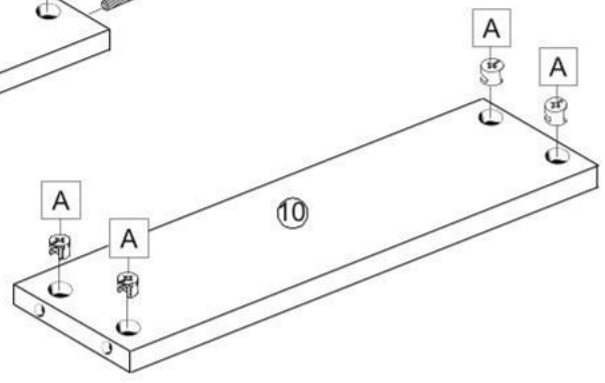
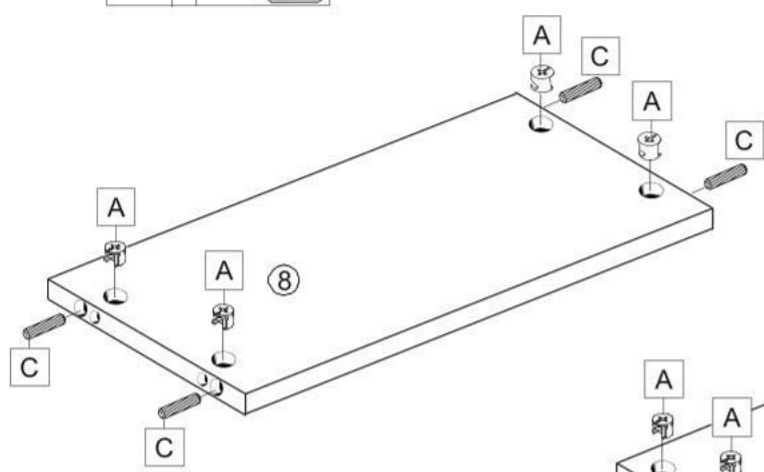
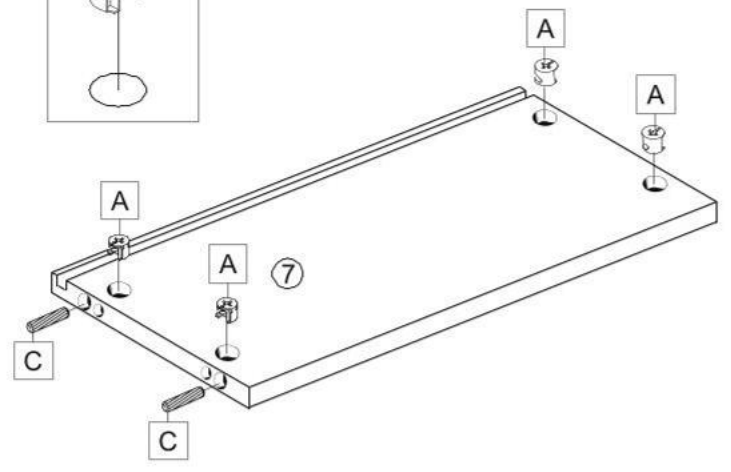
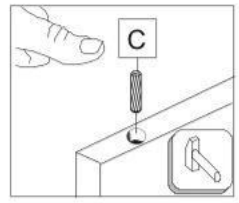
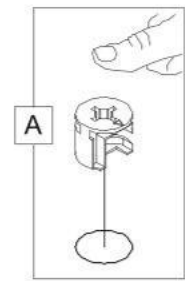
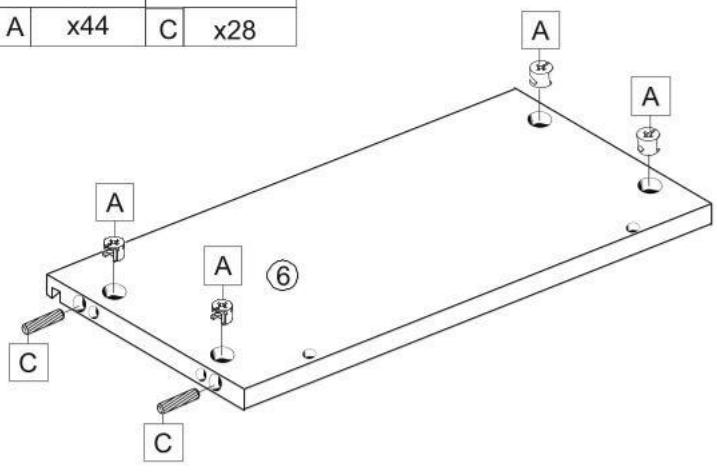

A	x44	C	x28
---	-----	---	-----

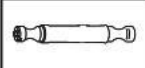

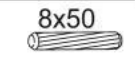

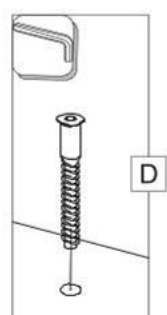
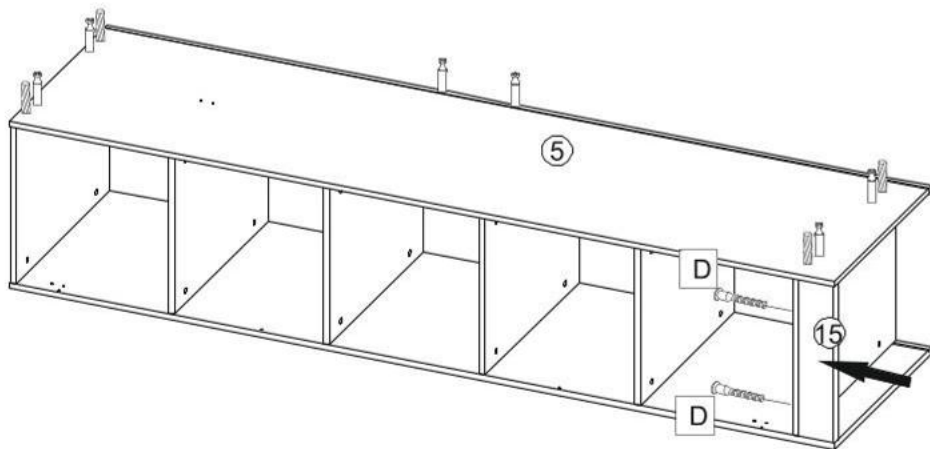
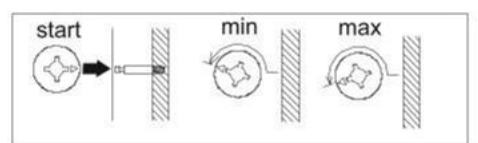
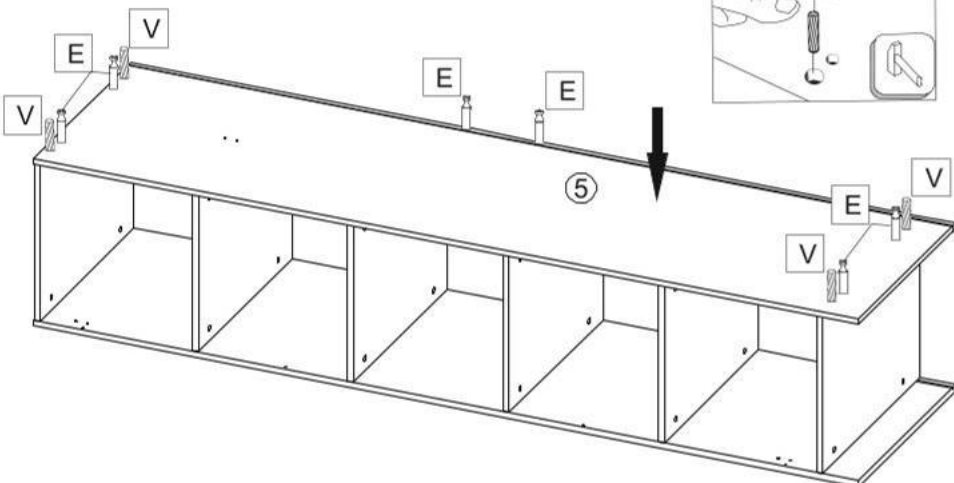
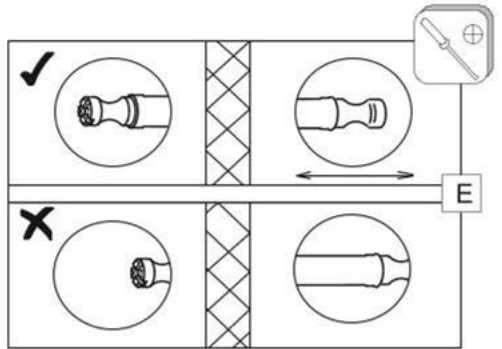
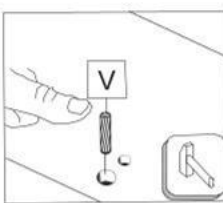
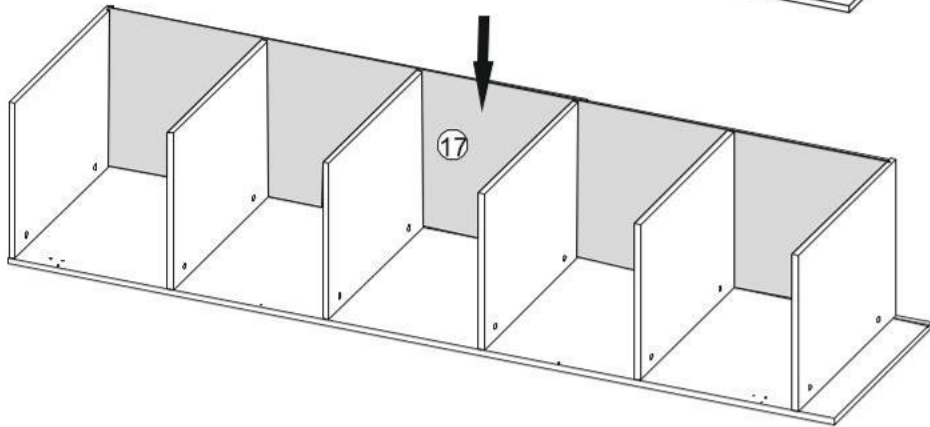
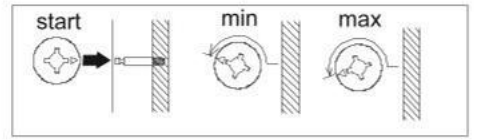
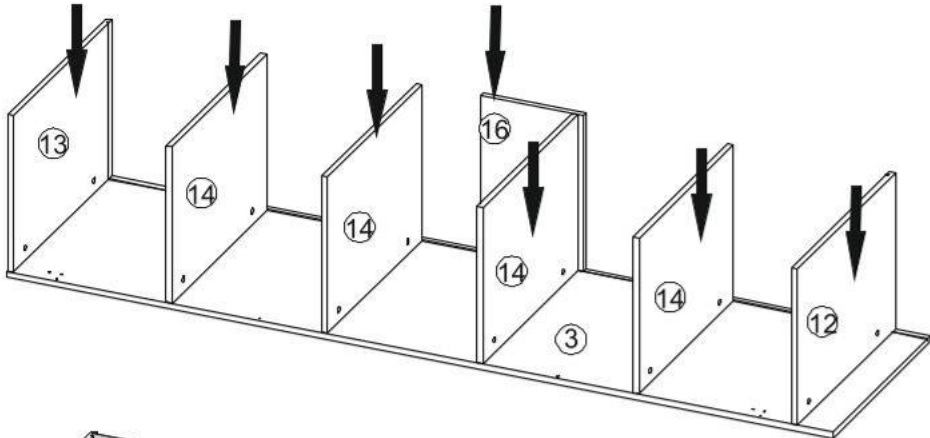
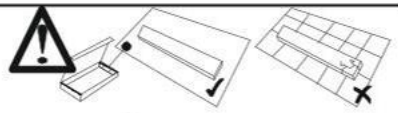
		
E x6	D x2	V x4



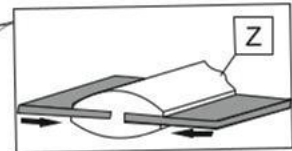
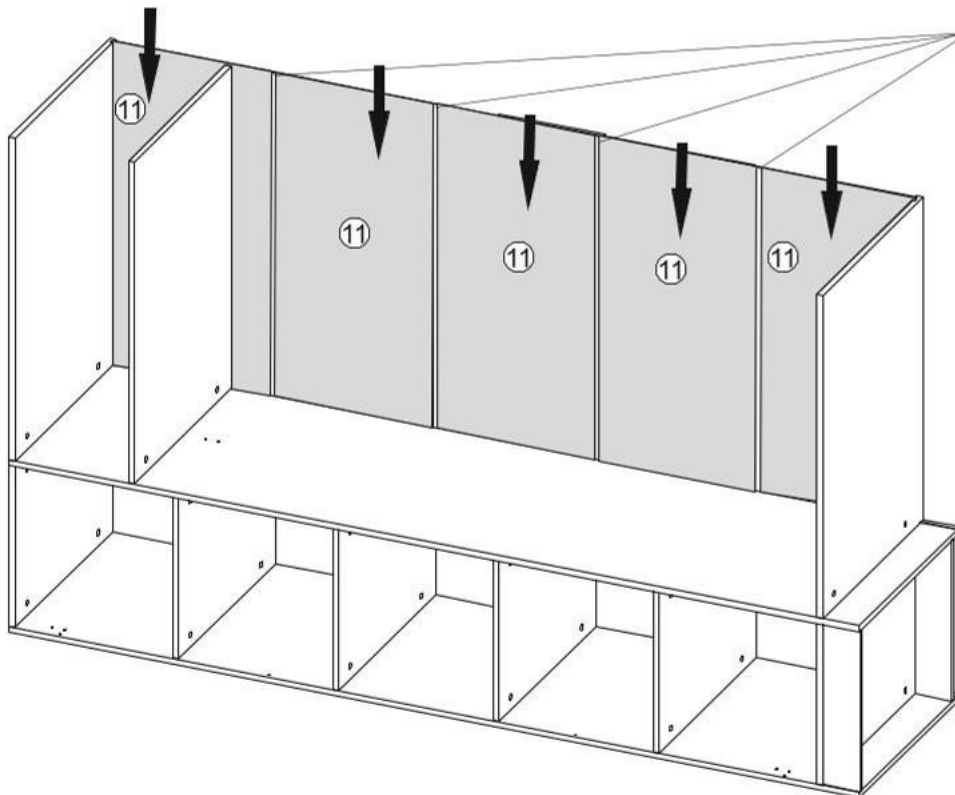
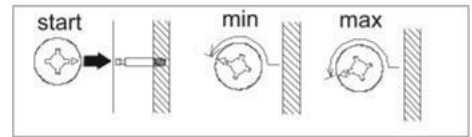
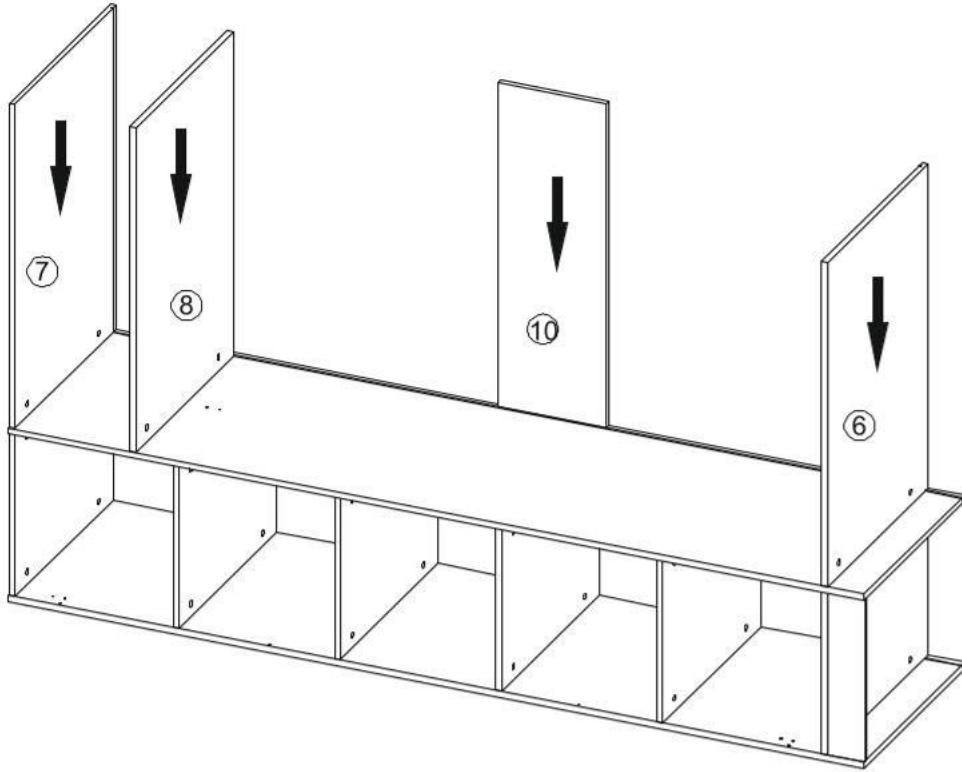
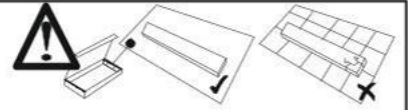



L=853
Z x4

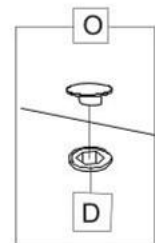
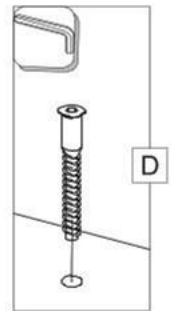
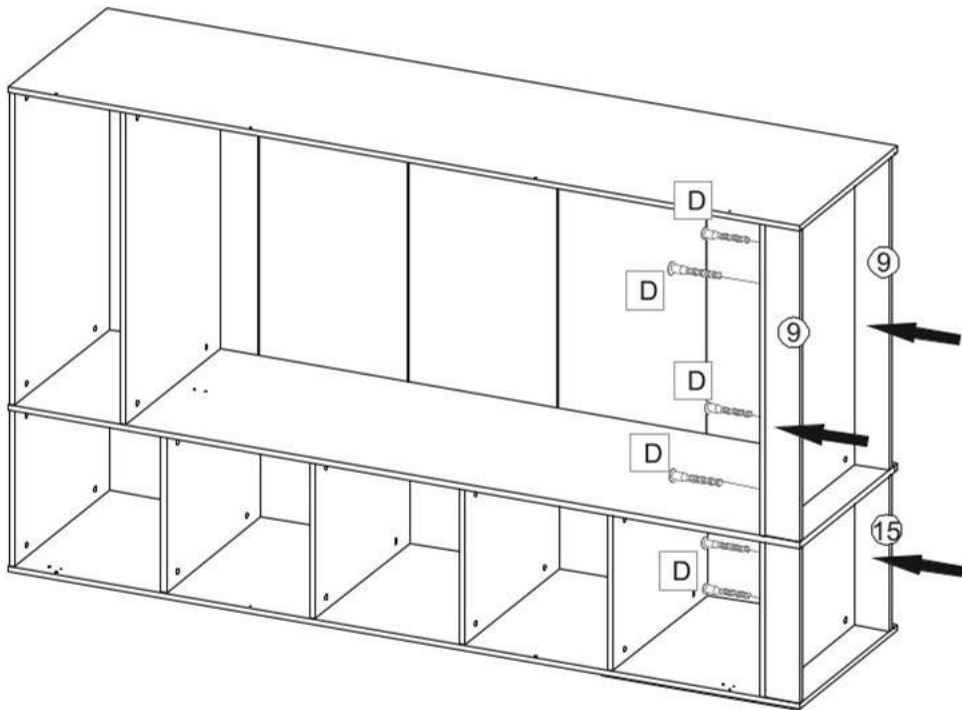
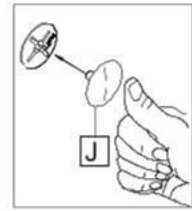
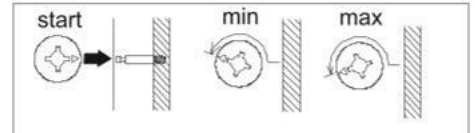
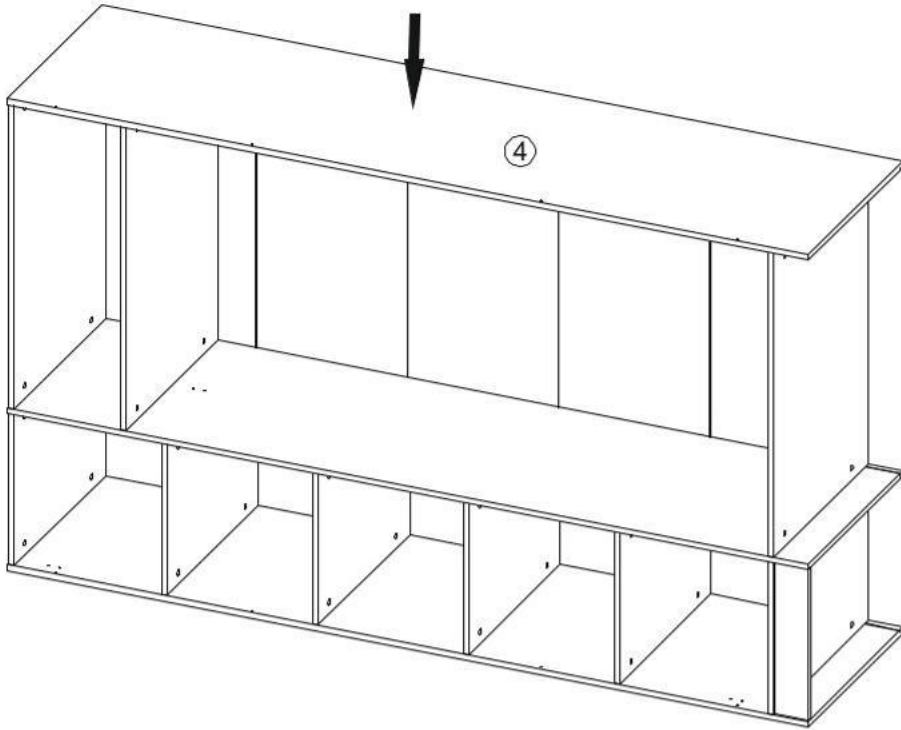
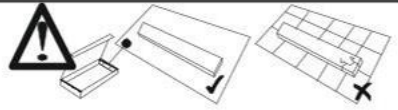



		
7x50	$\phi 18$	$\phi 14$
D x6	J x28	O x8



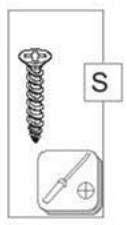
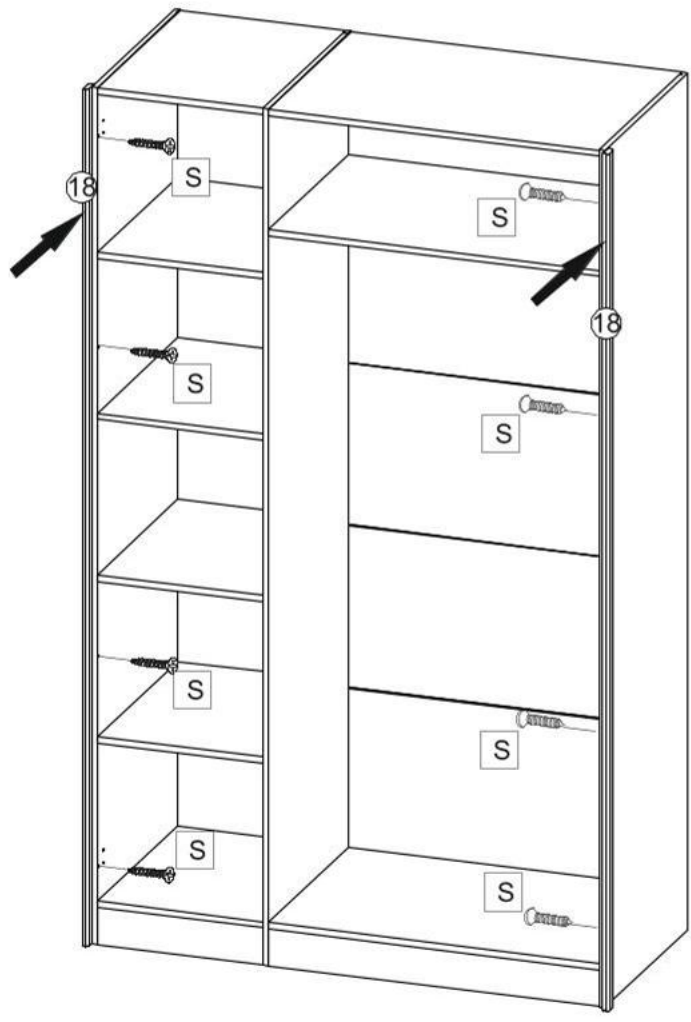
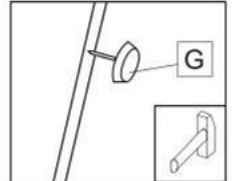
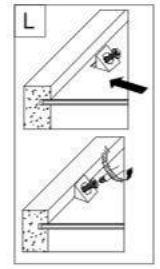
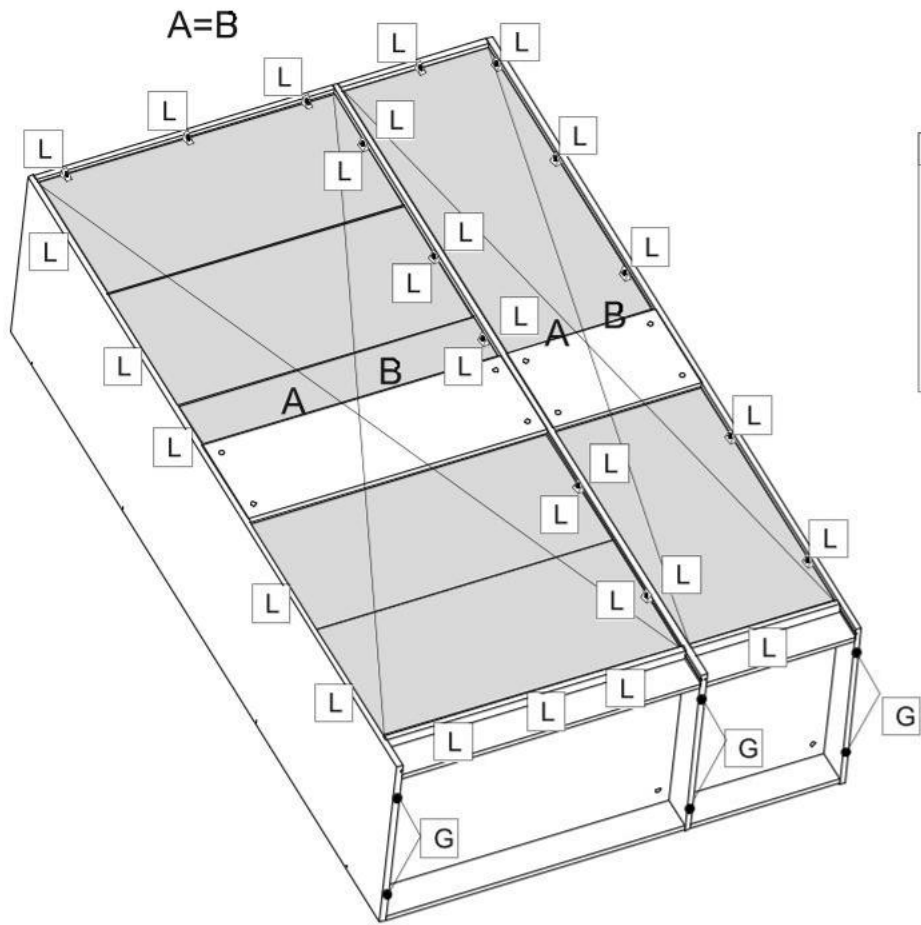
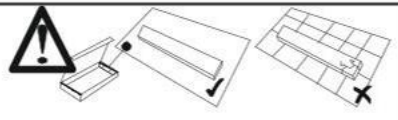



			
L	x30	S	x8
G	x6		

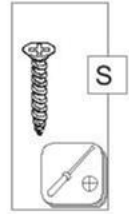
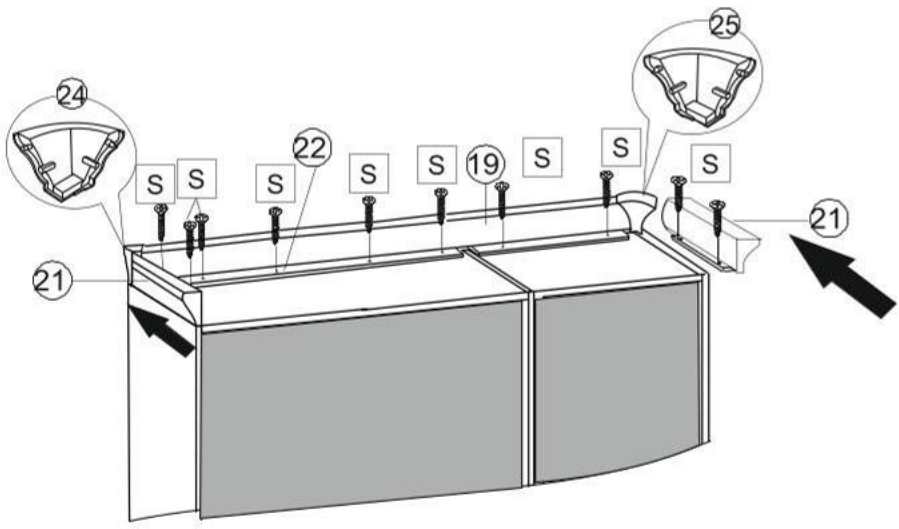
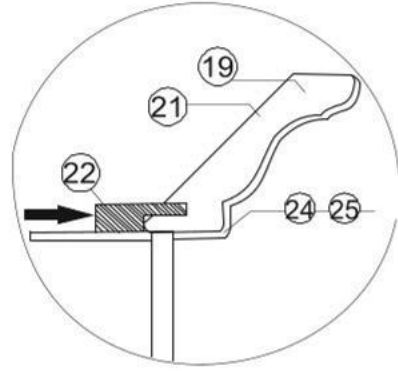
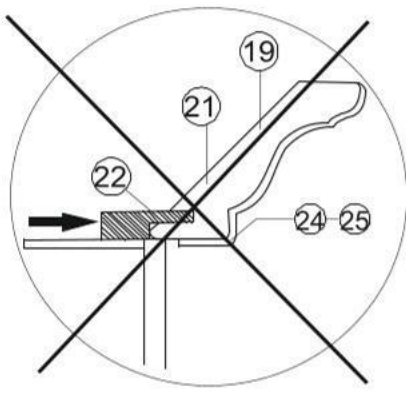
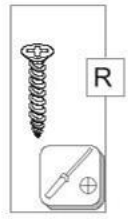
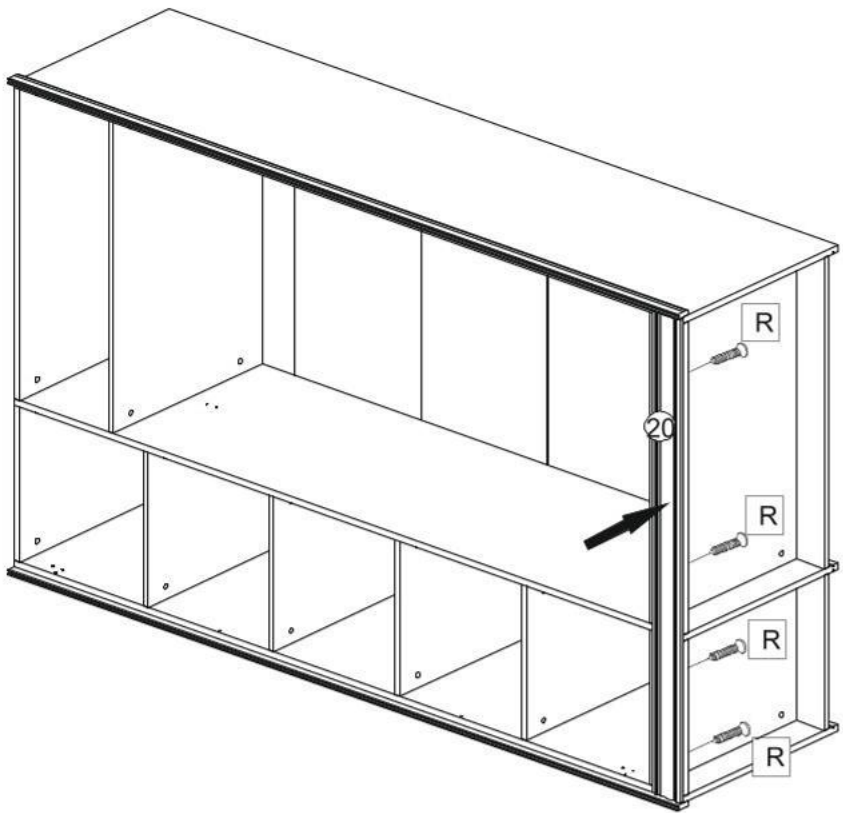
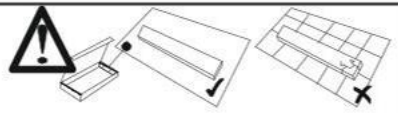



	
3,5x25	3,5x30
R x4	S x10

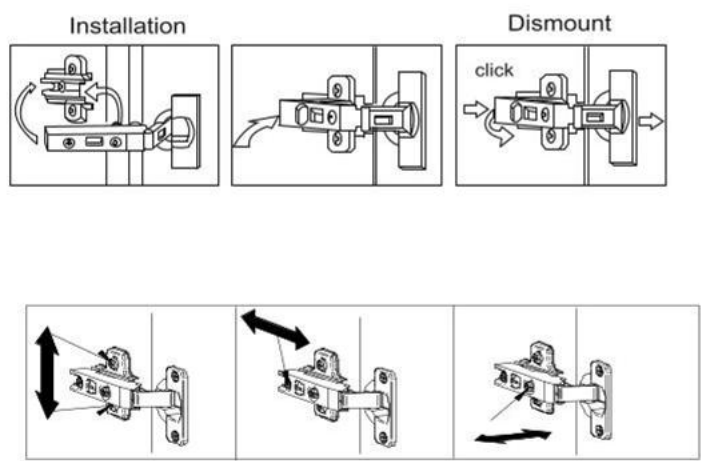
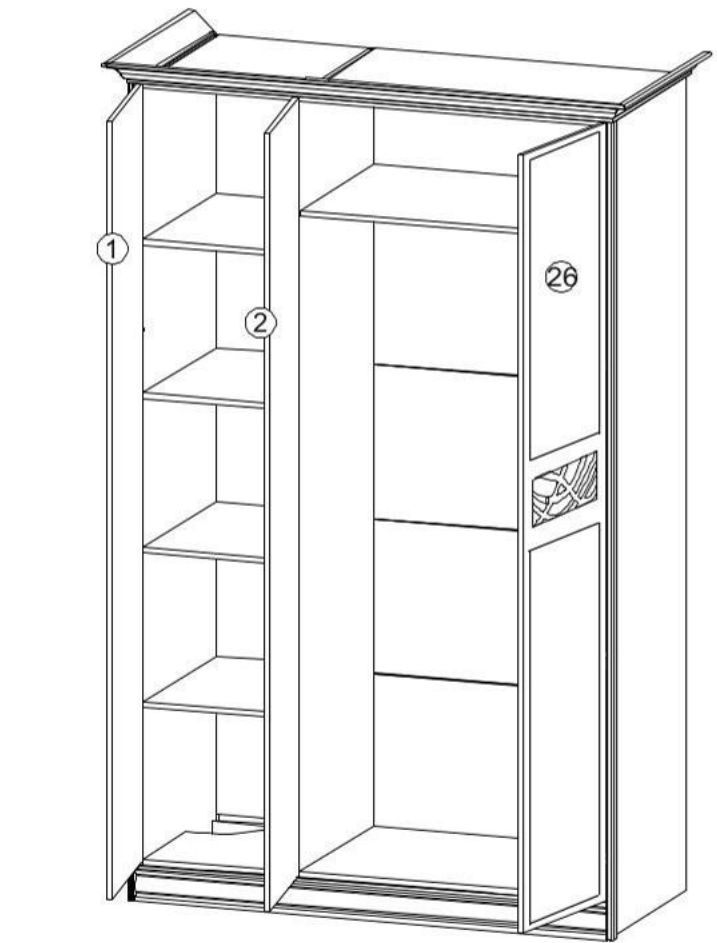
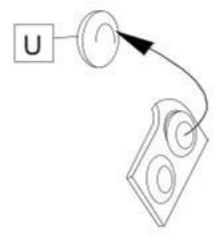
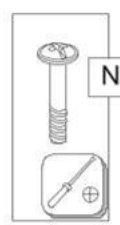
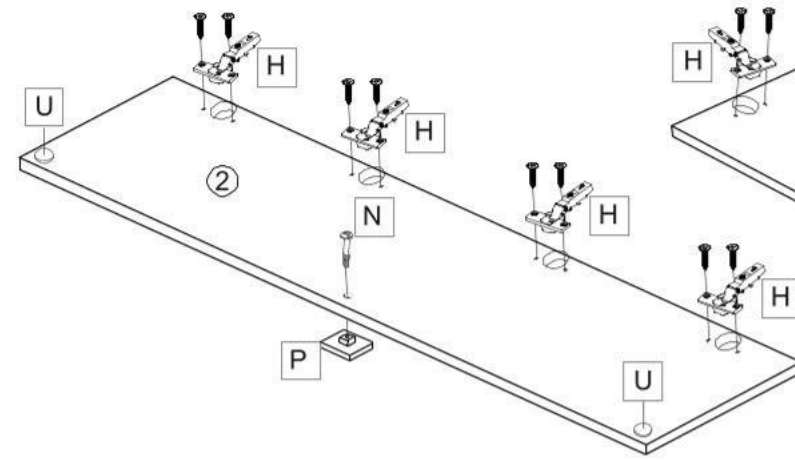
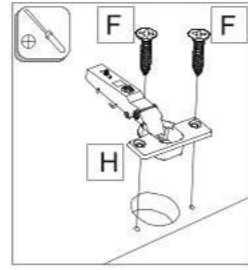
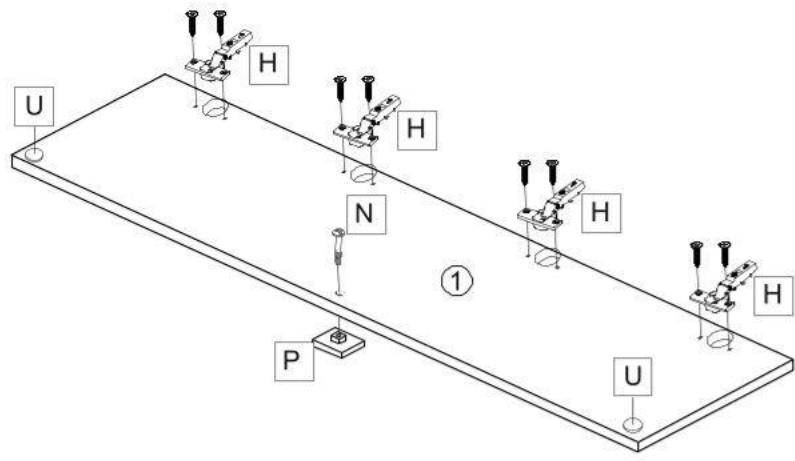
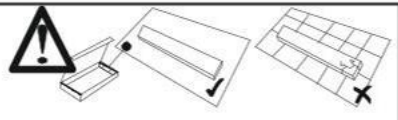

				
F x24	H x12	P x3	U x6	N x3



	L-847		K
Y	x1	K	x2

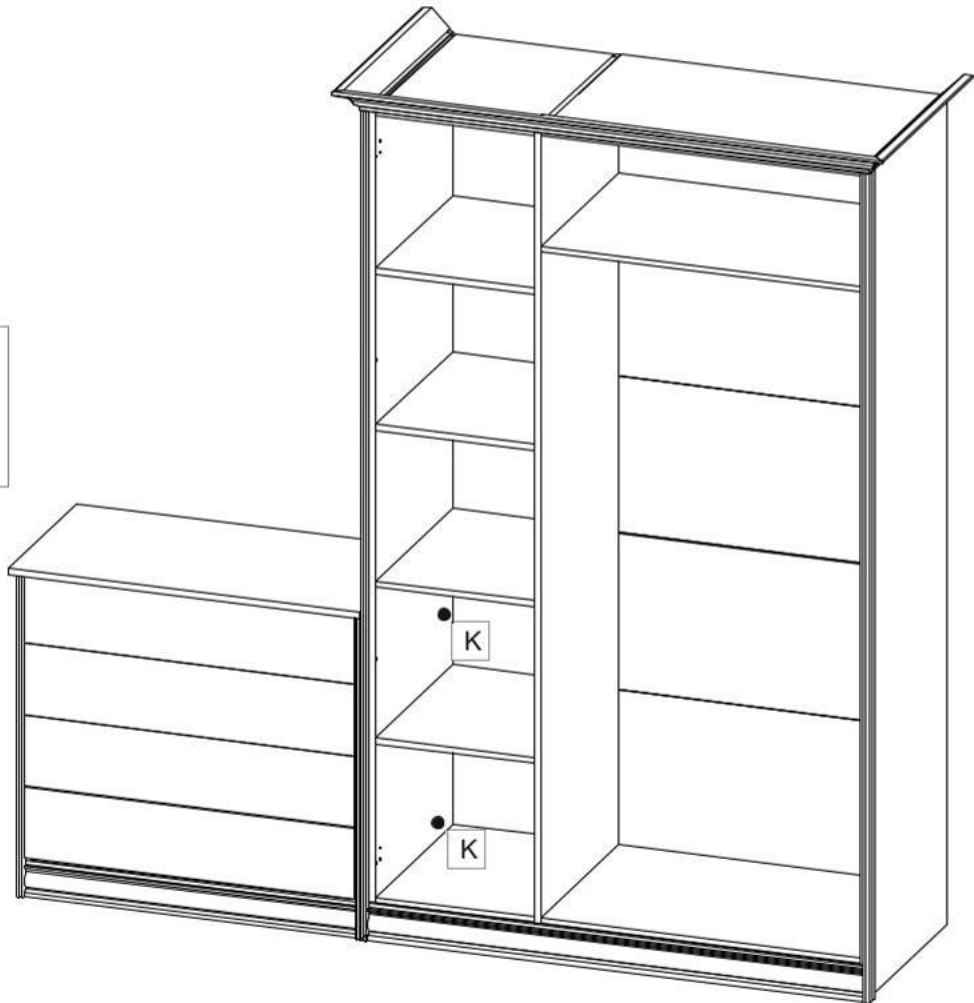
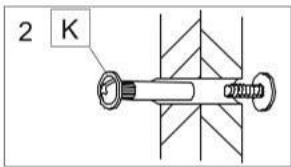
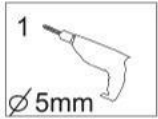
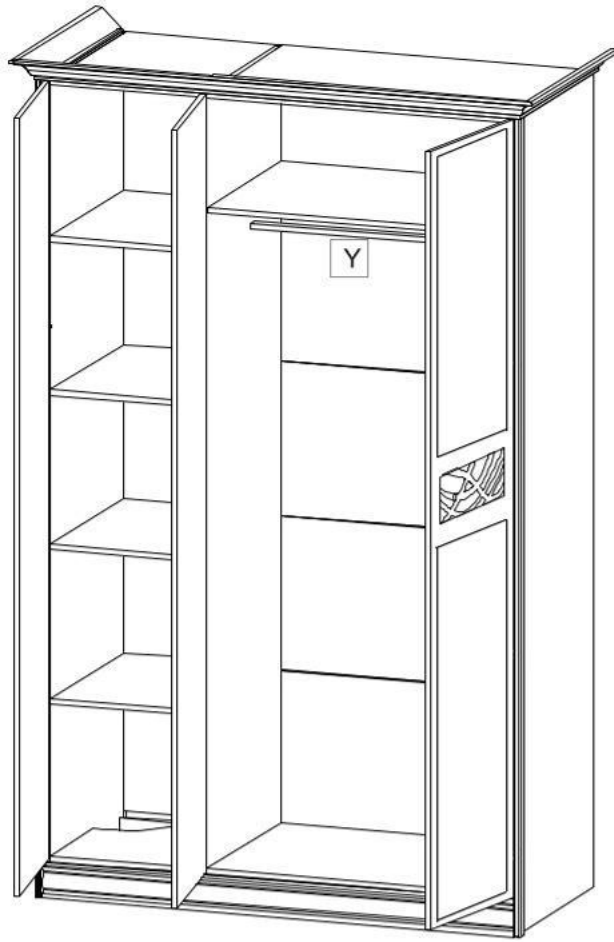
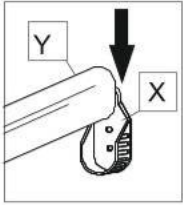
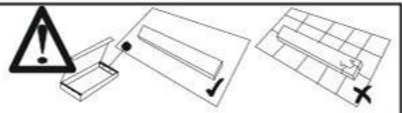

3,5x16			
F	x2	M	x1

