

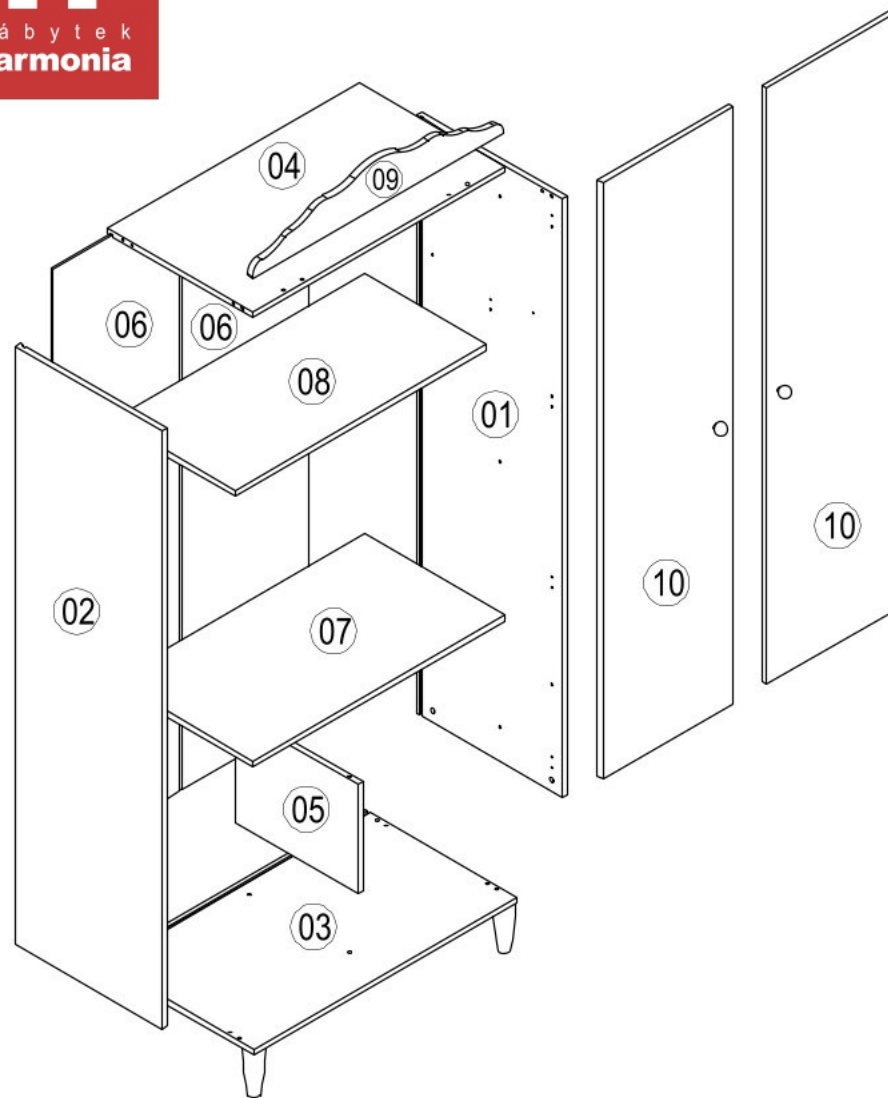

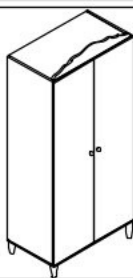













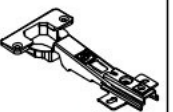
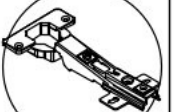

Šatní skříň 2D CHERE



<p>ACCESSORIE NO : 002 TITUS MÍNIFIX GÖVDE</p>  <p>12 ADET</p>	<p>ACCESSORIE NO : 001 MÍNIFIX MİL 6 MM</p>  <p>12 ADET</p>	<p>ACCESSORIE NO : 004 Ø8x30 KAVELA</p>  <p>8 ADET</p>	<p>ACCESSORIE NO : 020 MÍNIFIX TAPA BEYAZ</p>  <p>12 ADET</p>	<p>ACCESSORIE NO : 012 ASKI FLANŞI BEYAZ</p>  <p>2 ADET</p>
<p>ACCESSORIE NO : 406 PLS. RAF PİMİ EURO VİDASI</p>  <p>8 ADET</p>	<p>ACCESSORIE NO : 120 6,3*13 MM EURO VİDA</p>  <p>8 ADET</p>	<p>ACCESSORIE NO : 021 DÜZ MENTEŞE</p>  <p>4 ADET</p>	<p>ACCESSORIE NO : 182 FRENLİ DÜZ MENTEŞE</p>  <p>4 ADET</p>	<p>ACCESSORIE NO : 092 4*18 MM S. VİDASI</p>  <p>32 ADET</p>
<p>ACCESSORIE NO : 299 M6*25 VİDA</p>  <p>6 ADET</p>	<p>ACCESSORIE NO : 524 ARDIÇ AYAK PEMBE</p>  <p>6 ADET</p>	<p>ACCESSORIE NO : 011 ARKALIK SABITLEME 3,5x25 S.VİDASI</p>  <p>10 ADET</p>	<p>ACCESSORIE NO : 574 TOPUZ KULP</p>  <p>2 ADET</p>	<p>ACCESSORIE NO : 104 M4*25 MM VİDA</p>  <p>2 ADET</p>
<p>ACCESSORIE NO : 095 4*30 MM S. VİDASI</p>  <p>18 ADET</p>	<p>ACCESSORIE NO : 605 LED IŞIK</p>  <p>1 ADET</p>	<p>ACCESSORIE NO : 094 3,5*16 S. VİDASI</p>  <p>3 ADET</p>		<p>ACCESSORIE NO : 563 RAFİX MİL (11)</p>  <p>2 ADET</p>

NO	ADET/PCS	ÖLÇÜ/DIMENSIONS	NO	ADET/PCS	ÖLÇÜ/DIMENSIONS	NO	ADET/PCS	ÖLÇÜ/DIMENSIONS
01	1	1804 X 509						
02	1	1804 X 509						
03	1	916 X 530						
04	1	878 X 509						
05	1	424 X 331						
06	2	1796 X 441						
07	1	878 X 490						
08	1	878 X 426						
09	1	878 X 147						
10	2	1799 X 455						

PLEASE ORDER THE ACCESSORIES ACCORDING TO THE REFERENCE NUMBER ON THE DRAWING(EXAMPLE ACCESSORIE NO-008 RAFIX MIL 1.PCS.)

PLEASE ORDER THE SPARE PARTS ACCORDING TO THE REFERENCE NUMBER ON THE DRAWING

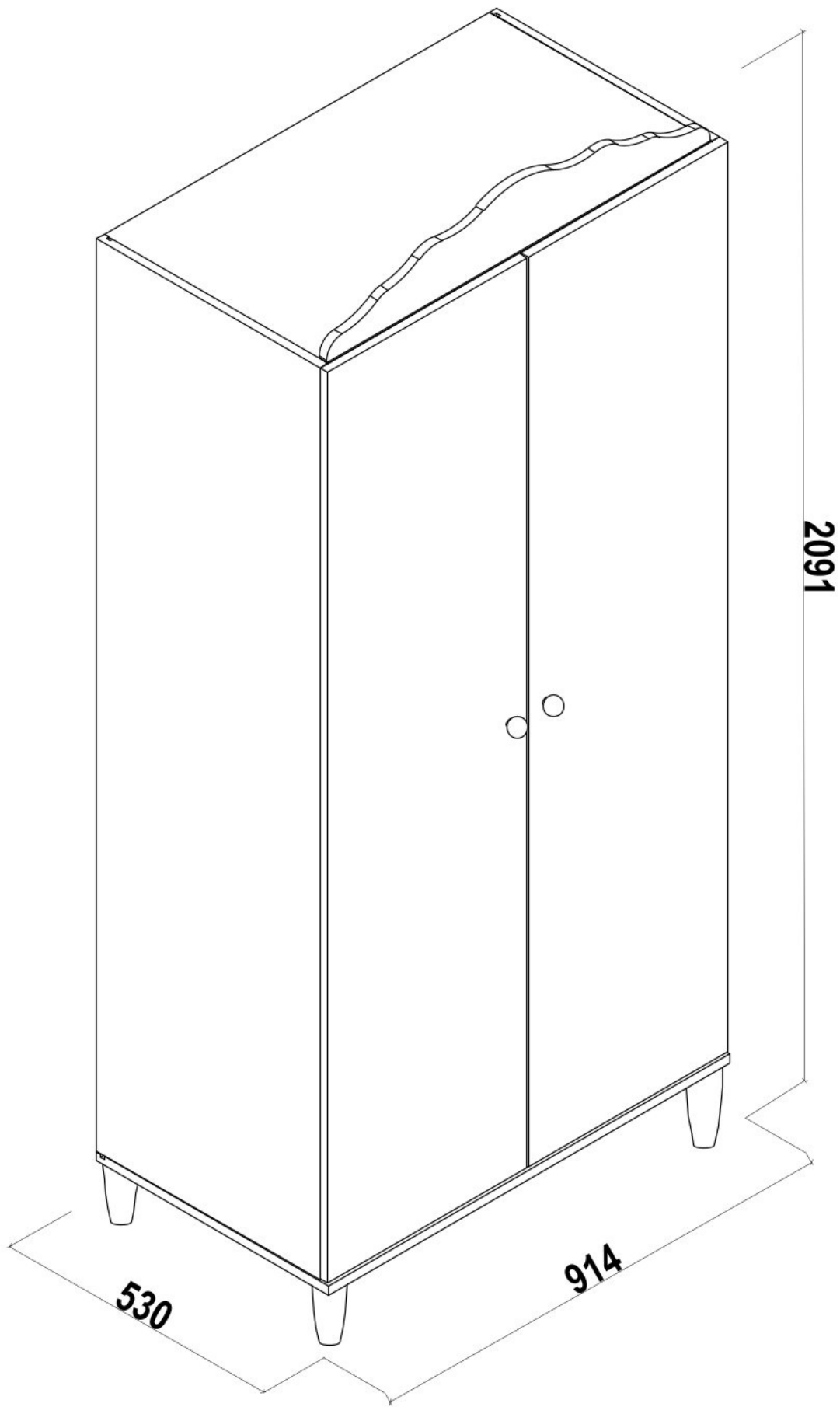

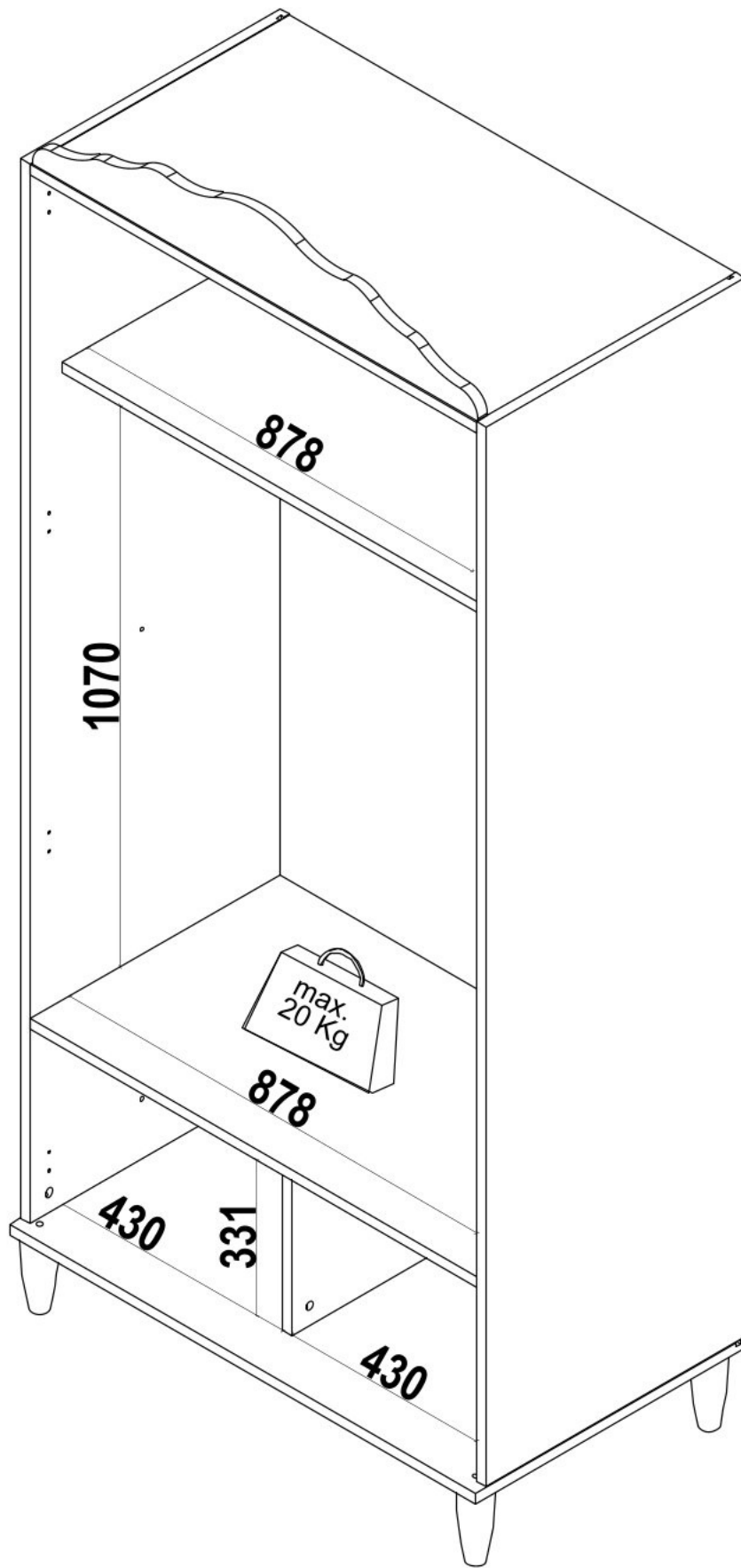

INSTALLATION STEPS

